

SDM120M

Single-Phase Multifunction DIN Rail Meter



- Measures kWh, kVArh, kW, kVA, PF, Hz, dmd, V, A, etc.
- Bi-directional measurement IMP & EXP
- Two pulse outputs
- RS485 Modbus RTU
- Din rail 35mm
- 45A direct connection
- Better than Class 1 accuracy

User Manual V3.0

Application

The energy-meters are used to measure single-phase applications like residential, utility and Industrial. The unit measures and displays various important electrical parameters. It equipped with a white back-lighted LCD screen for prefect reading. As well as a RS485 communication port for remote reading and monitoring. Bi-directional energy measurement makes it a good choice for solar PV energy metering. The compact design and din rail installation provides an easy and economical solution for your metering demand.

PART 1 Specification

General Specifications

Voltage AC (Un)	230V
Voltage Range	176~276V AC
Base Current (Ib)	5A
Max. Current (Imax)	45A
Mini Current (Imin)	0.25A
Starting current	0.4% of Ib
Power consumption	<2W/10VA
Frequency	50/60Hz(±10%)
AC voltage withstand	4KV for 1 minute
Impulse voltage withstand	6KV-1.2uS waveform
Overcurrent withstand	30Imax for 0.01s
Pulse output rate	
-Pulse Output 2	1000imp/kWh (default)
-Pulse Output 1	1000/100/10/1 imp/Exp/kWh/kVArh (configurable)
Display	LCD with white backlit
Max. Reading	99999.9kWh

Accuracy

Voltage	0.5% of range maximum
Current	0.5% of nominal
Frequency	0.2% of mid-frequency
Power factor	1% of Unity
Active power	1% of range maximum
Reactive power	1% of range maximum
Apparent power	1% of range maximum
Active energy	Class 1 IEC62053-21
	Class B EN50470-1/3
Reactive energy	Class 2 IEC62053-23

Environment

Operating temperature	-25°C to +55°C/-40°C to +70°C (optional)
Storage and transportation temperature	-40°C to +70°C
Reference temperature	23°C ± 2°C
Relative humidity	0 to 95%, non-condensing
Altitude	up to 2000m
Warm up time	3s
Installation category	CAT III
Mechanical Environment	M1
Electromagnetic environment	E2
Degree of pollution	2

Output

Pulse Output

The meter provides two pulse outputs. Both pulse outputs are passive type.

Pulse output 1 is configurable. The pulse output can be set to generate pulses to represent total / import/export kWh or kVArh.

The pulse constant can be set to generate 1 pulse per: 0.001(default) /0.01/0.1/kWh/kVArh.

Pulse width: 200/100/60ms

Pulse output 2 is non-configurable. It is fixed to total kWh. The constant is 1000imp/kWh.

RS485 output for Modbus RTU

The meter provides a RS485 port for remote communication. Modbus RTU is the protocol applied. For Modbus RTU, the following RS485 communication parameters can be configured from the set-up menu.

Baud rate: 1200, 2400, 4800, 9600 bps. Default: 2400

Parity: NONE/EVEN/ODD

Stop bits: 1 or 2

Modbus Address: 1 to 247 (default 1)



Mechanics

Din rail dimensions	18x118x64 (WxHxD) DIN 43880
Mounting	DIN rail 35mm
Ingress protection	IP51 (indoor)
Material	Self-extinguishing UL94V-0

PART 2 Operation

Initialization Display

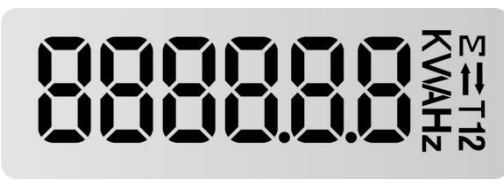
When it is powered on, the meter will initialize and do self-checking.

1		Full Screen It will last for 3 seconds.
2		Software version in kind prevail It will last for 3 seconds.



After the self-checking program, the meter display will show total active energy (kWh)









Scroll Display by Button

There is a button on the front panel of the meter.

After initialization and self-checking program, the meter display the measured values. The default page is total kWh. If the user wants to check other information, he needs to press the scroll button on the front panel.

	Press the button, the LCD display will scroll the measurements. Keep pressing the button for 3 seconds, the meter will enter into set-up mode.
---	---

1		Total active energy (kWh) Display format: 0000.00→9999.99→10000.0→99999.9→0000.00
2		Import active energy (kWh) Display format: 0000.00→9999.99→10000.0→99999.9→0000.00

3		Export active energy (kwh) Display format: 0000.00→9999.99→10000.0→ 99999.9→0000.00
4		Voltage (V)
5		Current (A)
6		Active power (W)
7		Frequency (F)
8		Power factor (PF)
9		Modbus address (ID) Default: 001
10		Baud rate Default : 2400bps

11		Parity None/even/odd are optional Default: none
12		Software version in kind prevail



Set-up Mode

To get into Set-up Mode, the user need keep pressing the button for 3 seconds, the meter will enter into the set-up mode.



The meter support to set three parameters : Address, Baud Rate, and Parity.

Notice: Under the “SET” mode, If there is no operation, the display will back to the default display.

Modbus Address setting



	Under this menu, long press the button for 3 seconds enter to the set up mode.
	The rightmost digit will flash, press the button to increase or decrease number, and then waiting for 4 seconds, the next digits will flash, press the button again to increase number, and waiting for 4 seconds, repeat above options until all the digits are set
	After the setting of final digit, waiting for 4 seconds, the address information will be stored automatically and the display will returned to the setting mode.

Baud rate setting

	Under this menu, long press the button for 3 seconds enter to the set-up mode.
	The digits will flash, press the button to choose baud rate options (from 1200 to 9600 bps), then waiting for 4 seconds

b 9600	the baud rate setting will be stored automatically after 4 seconds and the screen will return to the setting display.
--------	---

Parity setting

Prty n	Under this menu, long press the button  for 3 seconds enter to the set-up mode.
Prty n	The digits will flash, press the button  to choose parity options (None/Even/Odd), then waiting for 4 seconds Notice: n=None, e=Even, o= Odd
Prty o	the parity setting will be stored automatically after 4 seconds and the screen will return to the setting display.

The user can program the meter parameters by sending correct command via RS485 port.
The protocol is Modbus RTU. For the details. Please look at the "Eastron SDM120-M Modbus protocol".

Wiring Diagram

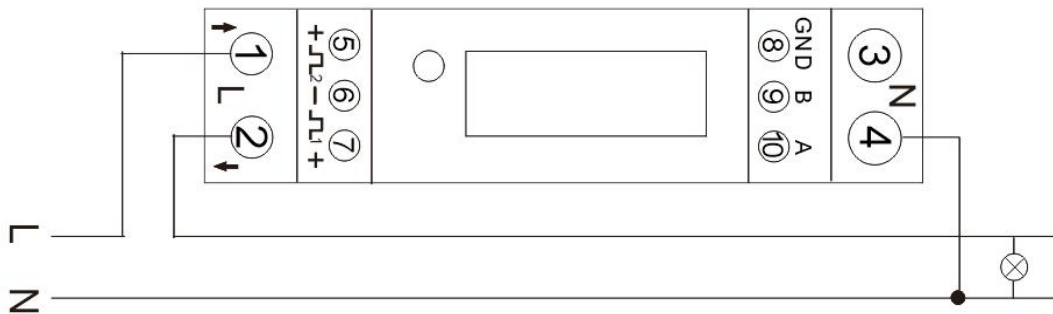

- 1 / 2: L-in/ L-out
- 3 / 4: N
- 5 / 6 / 7: Pulse Output 2 + / COM / Pulse Output 1 -
- 8 / 9 / 10: GND/RS485 B- / RS485 A+

Dimensions

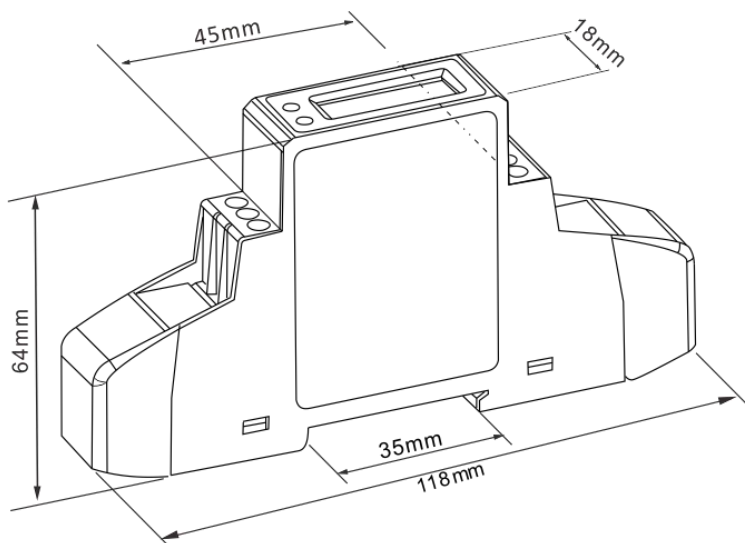

Installation

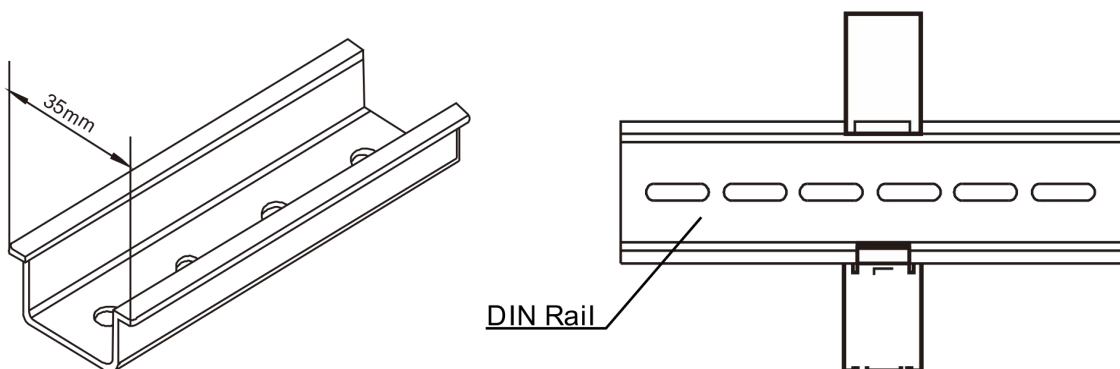

Modbus register Map

Function code	
04	to read input parameters

Address (Register)	Input Register Parameter			Modbus Protocol Start Address Hex	
	Parameters	Unit	Format	Hi byte	Low Byte
30001	Voltage	Volts	Float	00	00

30007	Current	Amps	Float	00	06
30013	Active power	Watts	Float	00	0C
30019	Apparent power	VA	Float	00	12
30025	Reactive power	VAr	Float	00	18
30031	Power factor	None	Float	00	1E
30071	Frequency	Hz	Float	00	46
30073	Import active energy	kWh	Float	00	48
30075	Export active energy	kWh	Float	00	4A
30077	Import reactive energy	kVArh	Float	00	4C
30079	Export reactive energy	kVArh	Float	00	4E
30085	Total system power demand	W	Float	00	54
30087	Maximum total system power demand	W	Float	00	56
30089	Import system power demand	W	Float	00	58
30091	Maximum Import system power demand	W	Float	00	5A
30093	Export system power demand	W	Float	00	5C
30095	Maximum Export system power demand	W	Float	00	5E
30259	current demand.	Amps	Float	01	02
30265	Maximum current demand.	Amps	Float	01	08
30343	Total active energy	kWh	Float	01	56
30345	Total reactive energy	kVArh	Float	01	58

Function code	
10	to set holding parameter
03	to read holding parameter

Address Register	Holding Register Parameter		Modbus Protocol Start Address Hex		Description
	Parameters	Format	Hi byte	Low byte	
40003	Demand Period	Float	00	02	Write demand period: : 0, 5,8, 10, 15, 20, 30, 60 minutes, default 60. Setting the period to 0 will cause the demand to show the current parameter value, and demand max to show the maximum parameter value

					since last demand reset.
40013	Pulse 1 Width	Float	00	0C	Write Pulse 1 Width in milliseconds: 60, 100 or 200, default 60ms. Length : 4 byte Data Format : Float
40019	Network Parity Stop	Float	00	12	Write the network port parity/stop bits for MODBUS Protocol.where: 0 = One stop bit and no parity, 1 default.= One stop bit and even parity. 2 = One stop bit and odd parity. 3 = Two stop bits and none parity. Requires a restart to become effective. Length : 4 byte Data Format : Float
40021	Meter ID	Float	00	14	Ranges from 1 to 247, Default ID is 1. Length : 4 byte Data Format : Float
40029	Baud rate	Float	00	1C	Write baud rate for MODBUS Protocol, where: 0 = 2400 baud (default) 1 = 4800 baud. 2 = 9600 baud 5=1200 baud . Length : 4 byte Data Format : Float
40087	Pulse 1 output mode	Float	00	56	Write MODBUS Protocol input parameter for pulse out 1: 0001: Import active energy, 0002: Total active energy (Imp + exp) 0004: Export active energy (default). 0005: Import reactive energy 0006:Total reactive energy (Imp+ exp) 0008: Export reactive energy Length : 4 byte Data Format : Float
461457	Reset historical data	Hex	F0	10	00 00: reset demand info Length : 2 byte Data Format : Hex
463745	Time of scroll display	BCD	F9	00	0-30s Default 0:does not display in turns Length : 2 byte Data Format : BCD

463761	Pulse 1 output	Hex	F9	10	0000:0.001kWh/imp(default) 0001:0.01kWh/imp 0002:0.1kWh/imp 0003:1kWh/imp Length : 2 byte Data Format : HEX
463777	Measurement mode	Hex	F9	20	0001:mode 1 (total = import) 0002:mode 2 (total = import + export) (default) 0003:mode 3 (total = import - export) Length : 2 byte Data Format : HEX
464513	Serial number	Unsigned int32	FC	00	Serial Number Length : 4 byte Data Format: Unsigned int32
464515	Meter code	Hex	FC	02	Meter code = 00 20 Length: 2 bytes Data Format: Hex Note: read only